



moto
gadget
instruction manual
mo.switch basic

V1.0

THIS PRODUCT CAN HANDLE CURRENTS OF MAX. 0,1A AND IS NOT SUITABLE TO SWITCH LOADS DIRECTLY. LOADS MUST BE SWITCHED BY A ELECTRONIC SWITCHING MODULE (i.e. MO.UNIT).

Thank you very much for purchasing a high quality motogadget product - Made in Germany.

Please read the following information and recommendations thoroughly and follow these instructions during installations and use of the product. No liability shall be assumed by motogadget for damage or defects resulting from negligence or failure to follow the operating and installation guide.

Contact:

motogadget GmbH
Köpenicker Str. 145
D - 10997 Berlin
Germany

Tel. +49 (0)30-6900410-0
www.motogadget.de
info@motogadget.de

Copyright © 2009-2019 *motogadget* GmbH, Berlin.
motogadget are registered trademarks of
motogadget GmbH, Berlin, Germany.

1. Review of Delivery

All products from motogadget are thoroughly checked to ensure they are completely fault-free when dispatched. Please check the received goods immediately for possible transport damage. If you find any damage or other deficiencies, please contact us immediately.

In this regard, we refer to our General Terms of Business and Delivery, which are published at www.motogadget.com. Should a return of the received delivery be agreed, please note that we only take back goods in their original packaging. The motorcycle and its accessories must be returned within the legal period of time and without any traces of use. We shall not assume any liability for returns which are insufficiently insured or packed.

2. Exclusion of Liability

THE DEVICE AND ITS ACCESSORIES MUST BE INSTALLED BY A CERTIFIED MOTORCYCLE TECHNICIAN AND IN AN AUTHORIZED SERVICE CENTER. MOTOGADGET ACCEPTS NO LIABILITY FOR DIRECT OR INDIRECT DAMAGE OR SUBSEQUENT DAMAGE OF ANY KIND RESULTING FROM THE USE, INSTALLATION OR CONNECTION OF THE DEVICE OR OTHER DELIVERED EQUIPMENT. THIS EXCLUSION OF LIABILITY PARTICULARLY INCLUDES DAMAGE TO PERSONS, MATERIAL LOSSES AND FINANCIAL DAMAGES. THE USE IN AREAS OF PUBLIC TRAFFIC ENSUES AT THE USER'S OWN RISK. THE USE OF THE DELIVERED DEVICE AND ITS ACCESSORIES FOR RACING OR OTHER COMPETITIONS AS WELL AS FOR ANY USE NOT CORRESPONDING TO THE RECOMMENDED APPLICATION ALL WARRANTY CLAIMS SHALL BE INVALID.

3. Safety Instructions

- **THE VEHICLE BATTERY MUST BE COMPLETELY DISCONNECTED PRIOR TO ANY WORK ON THE VEHICLE'S ELECTRICAL SYSTEM. FIRST, DISCONNECT THE NEGATIVE TERMINAL AND THEN THE POSITIVE TERMINAL. FOR RECONNECTION PROCEED IN THE REVERSE ORDER**
- **USING THE MO.SWITCH WITH PLUS POLE CONNECTED TO VEHICLE FRAME (OLDER ENGLISH MOTORCYCLES) IS NOT POSSIBLE.**
- **INSTALLATION AND ELECTRICAL CONNECTION OF THE MO.UNIT MAY ONLY BE CARRIED OUT BY A CERTIFIED MOTORCYCLE TECHNICIAN.**
- **ALL CABLE DIAMETERS MUST BE DIMENSIONED ACCORDING TO THE CURRENT FLOW**
- **ALL ELECTRICAL CONNECTIONS IN THE WIRING LOOM AND AT THE CONNECTION TERMINALS HAVE TO BE CARRIED OUT PROFESSIONALLY. FAILURES AT CONNECTING JOINTS MAY CAUSE A CONTACT RESISTANCE AND LEAD TO HEAT GENERATION DURING HIGH CURRENT FLOW. THERE IS A RISK OF SERIOUS OR LETHAL INJURIES.**

4. mo.switch combinations

4 push buttons - kickstarter & no instrument



5 push buttons - kickstarter & instrument or E-starter & no instrument

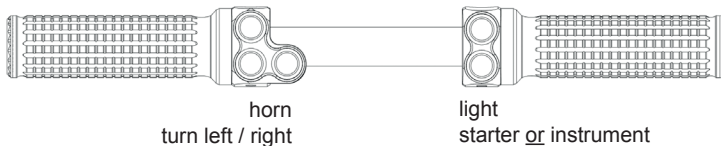

6 push buttons - E-starter & instrument

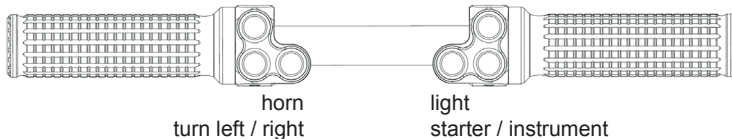

5. Setup

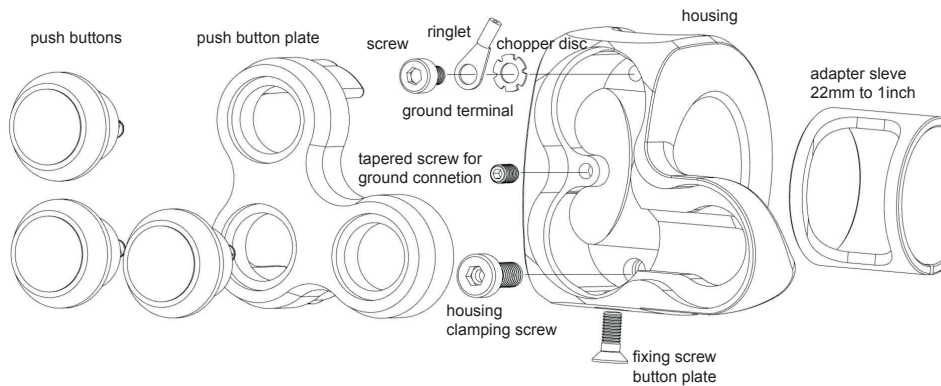

6. Wiring

Mount all handlebar attachments
and finalize their position.

Clamp mo.switch housing to handlebar.

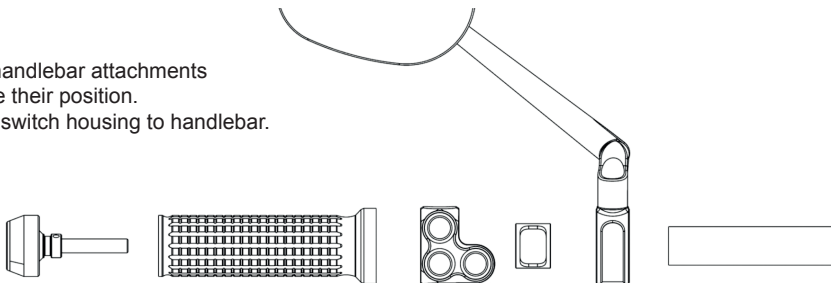

Drill 4 holes with 5mm diameter into the
handlebar. Deburr the holes inside and
outside carefully.

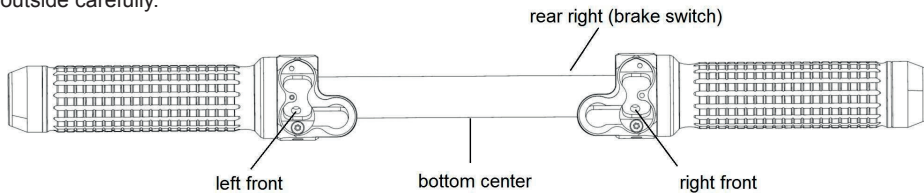

7. Wiring

7.1 Ground connection to handlebar

With an ohmmeter, the resistance between battery negative pole and the handlebar surface is measured. If the resistance is higher than 3 ohms, a separate ground wire must be routed from the negative battery terminal to one of the mo.switch housing ground points.

Handlebars that are not made of metal, e.g. Carbon, need a separate ground wire from the battery negative terminal to each of the mo.switch housing ground points.

When tightening the M3 grub screw into the mo.switch housing, the tip of the screw penetrates the handlebar surface and thus creates a secure ground connection between the handlebar and the housing.

The further ground connection for the pushbuttons is then carried out with the grounding cables supplied; connected at the mo.switch ground point with the M3 screw and the eyelet. In the process the supplied chopper disc is placed between the eyelet and the housing.

The free ends of the grounding cables are connected to a terminal contact of each button. The polarity does not matter.

All further ground connections, e.g. for the indicators and brake switch also carried out by using a mo.switch housing ground point.

7.2 Standard wiring

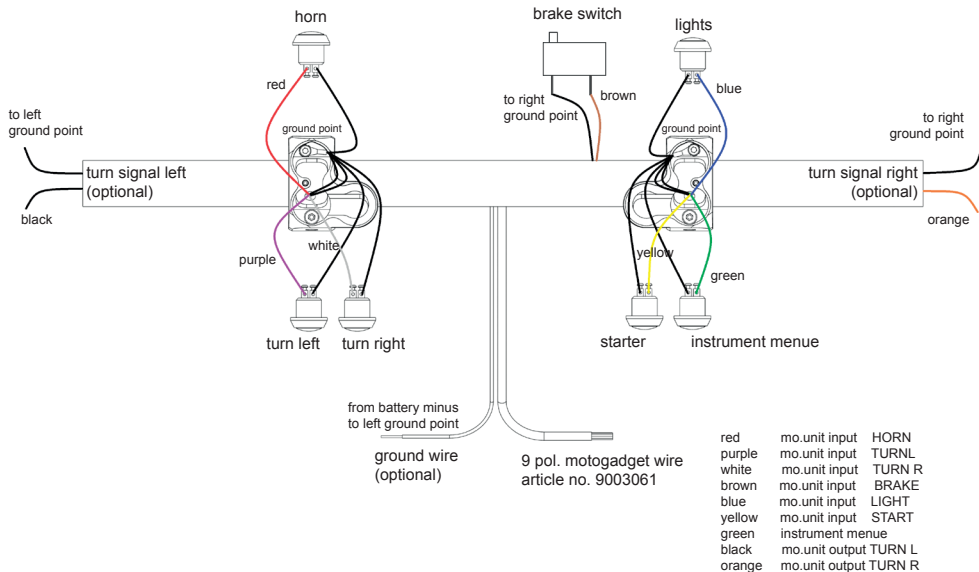

7.3 Wiring with mo.button

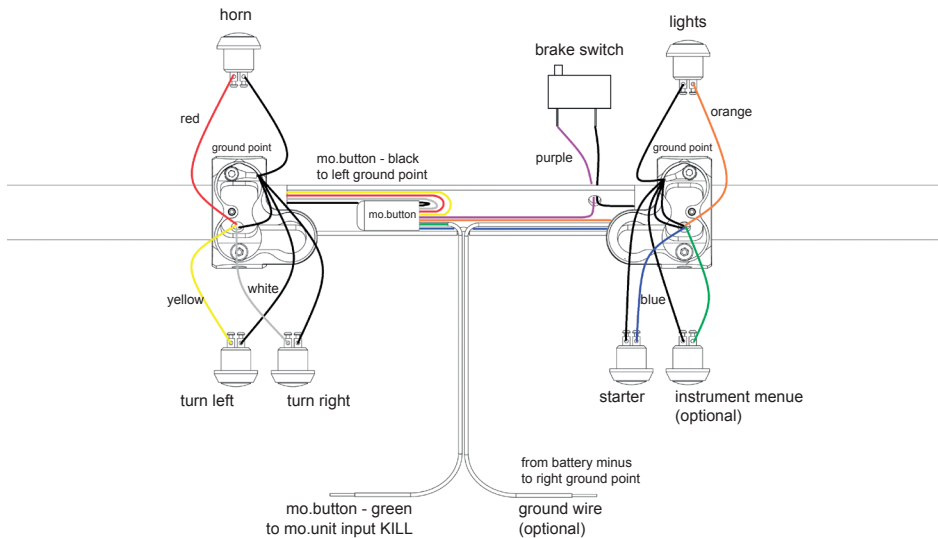

7.4 Using the delivered cable connection sleeves

